

WALL CAPS
SECTION 3

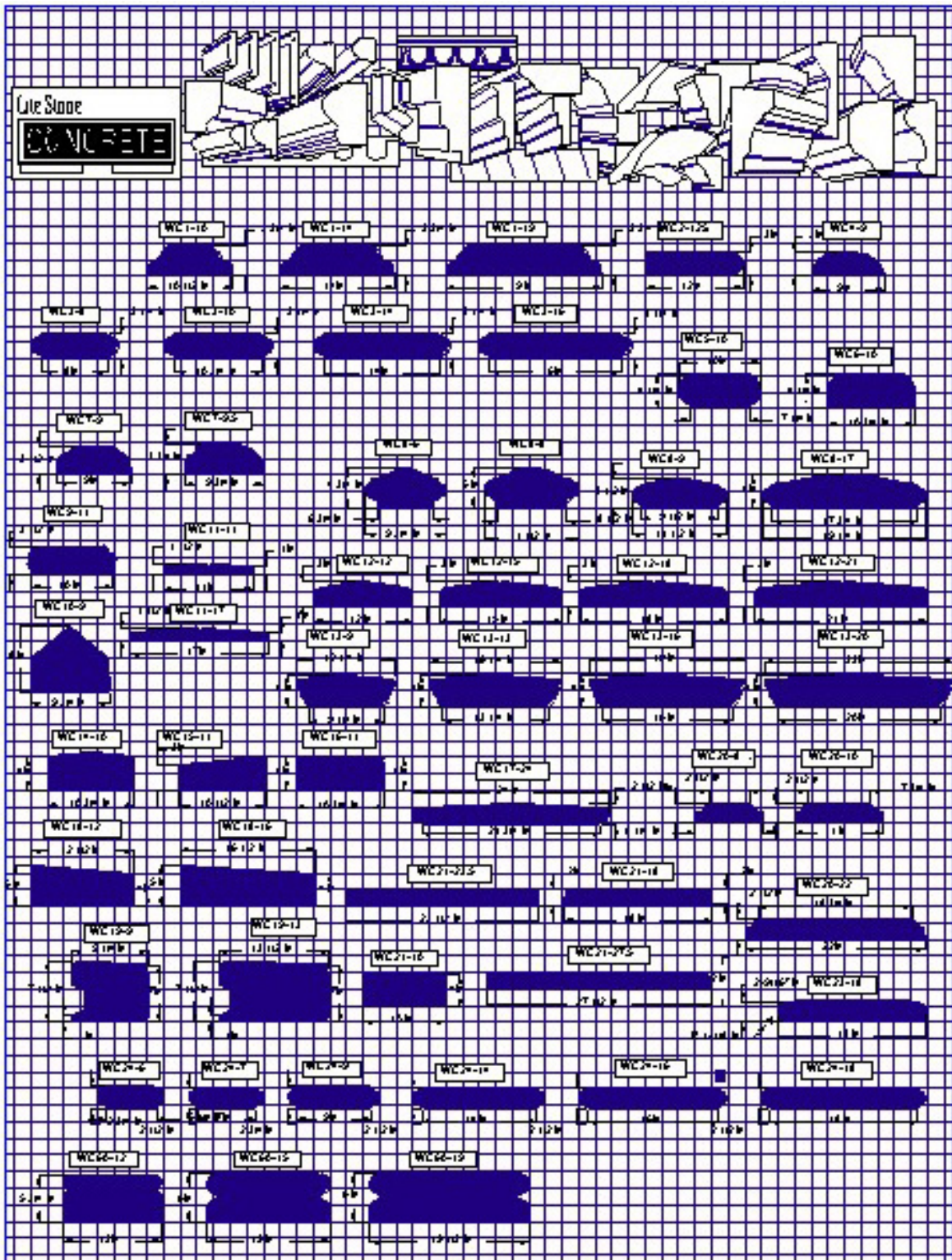

Wall caps, which are generally produced in 24 inch lengths, are available in a wide variety of styles and widths. Sizes are usually measured at the footprint of the cap (the flat bottom surface of the cap which sets upon the top surface of the wall). The footprint of the wall cap should be slightly wider than the wall width in order to accommodate any slight irregularities which might exist in the width of the wall. This is especially applicable where stucco covered block walls are laid on a radius.

Many of our wall caps are available in radius sizes; however others will require a custom mold in order to produce your required curve. Arc radii are measured at the bottom of the inside edge of the foot print. Please consult our sales staff in order to determine if an existing radius is available in the cap style which you have selected.



Quick Reference - Wall Caps 1

WALL CAP

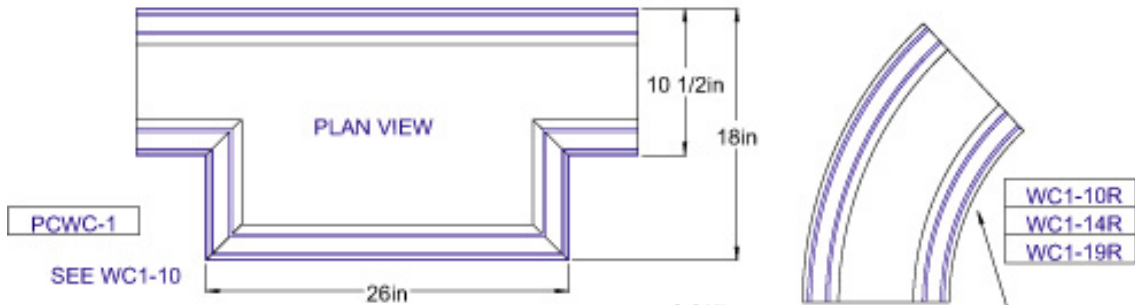
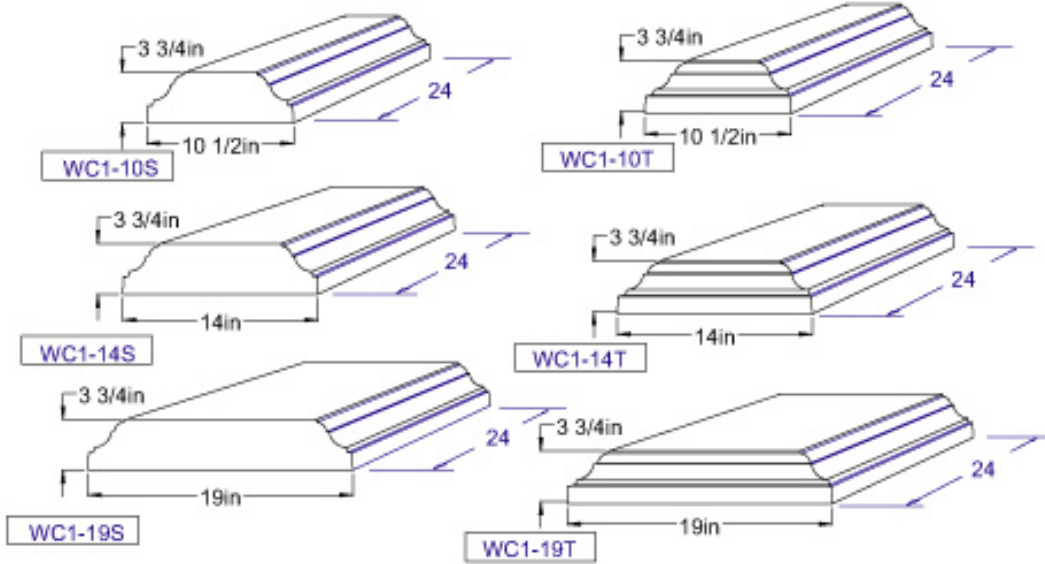

PILASTER/WALL CAP FOR 8-8-16 CMU WITH STUCCO

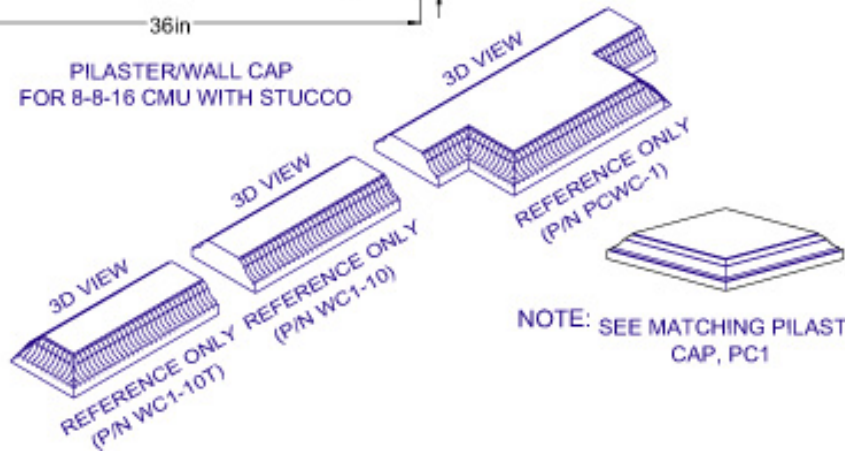

WALL CAP

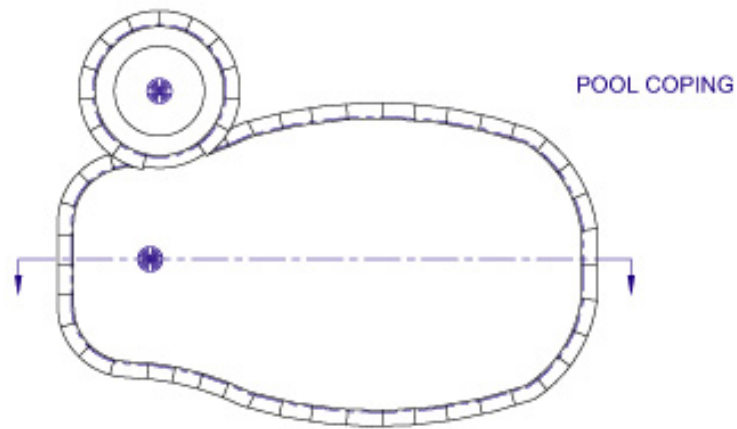
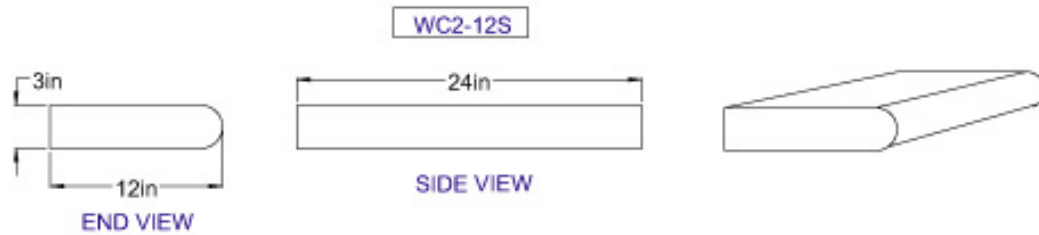
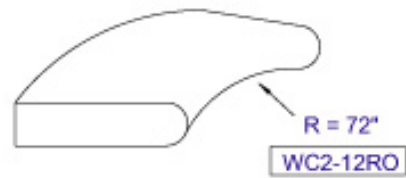
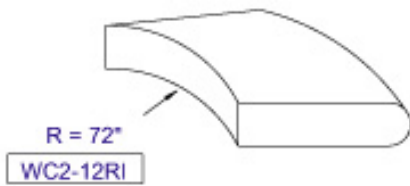

3 - 2

WALL CAP

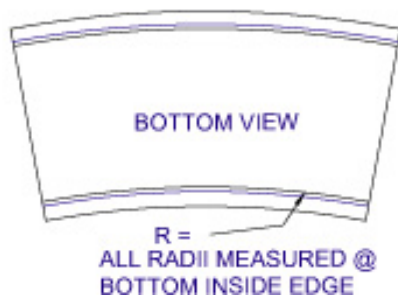
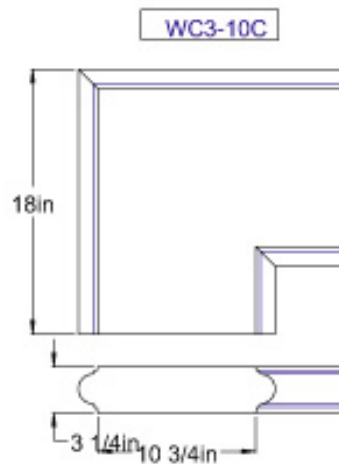
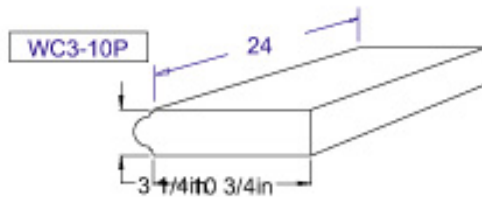
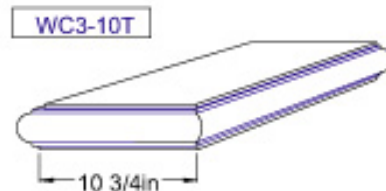
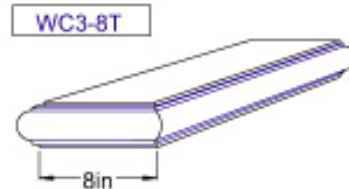
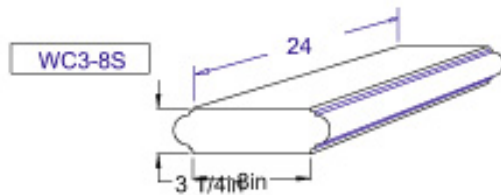

WALL CAP

WC3-14S

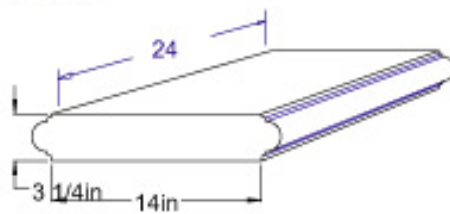

WC3-14T

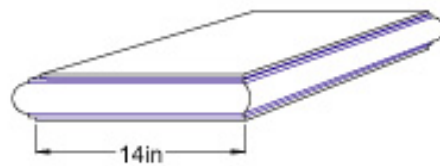

WC3-16S

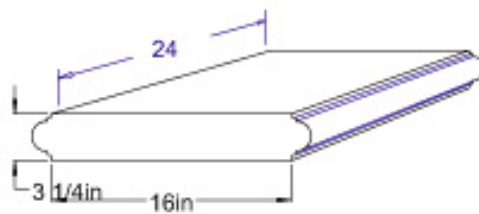

WC3-16T

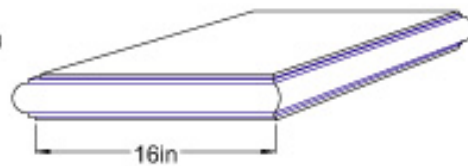

WC3-20P

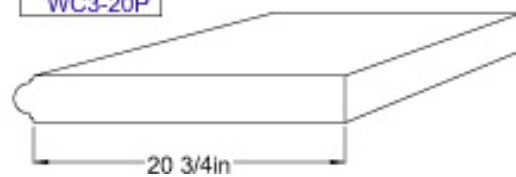

3 - 4

WALL CAP

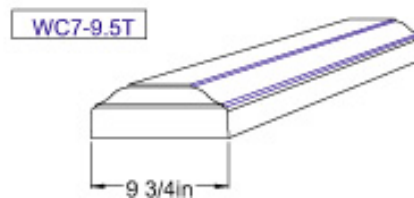
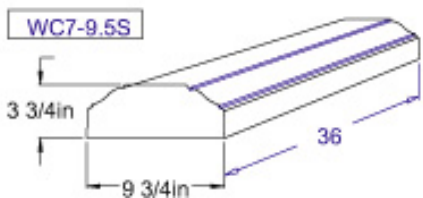
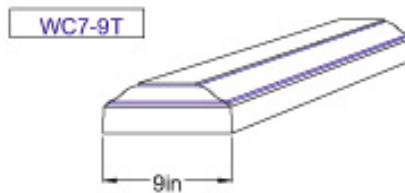
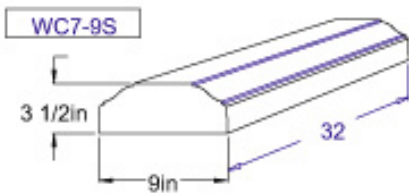
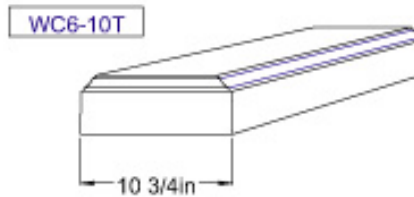
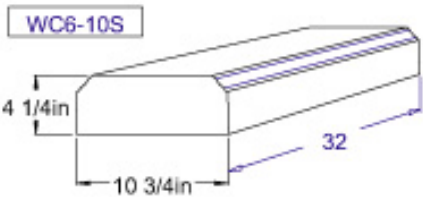
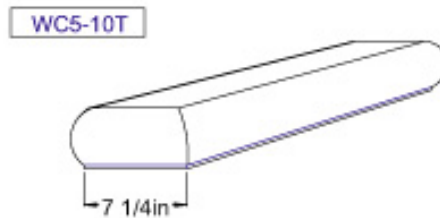
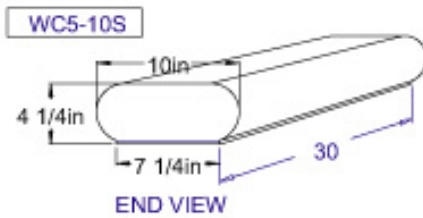
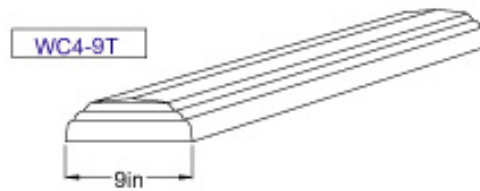
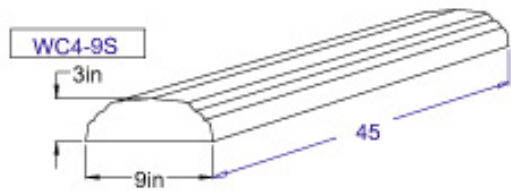

WALL CAP

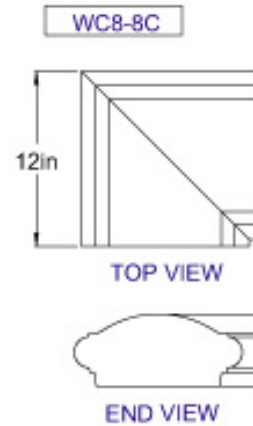
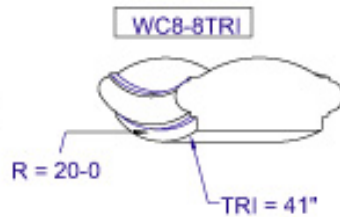
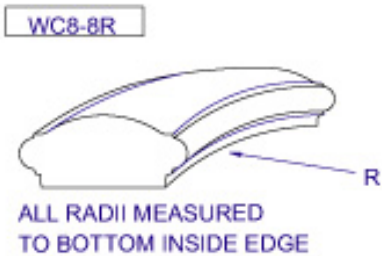
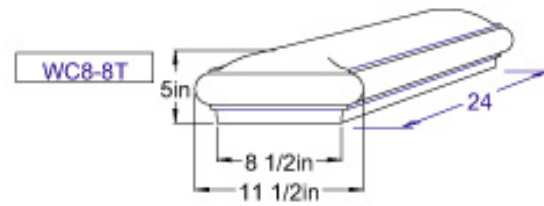
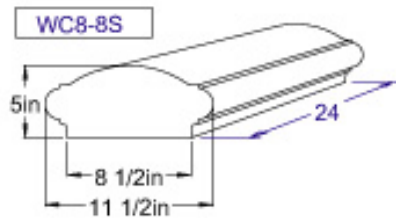
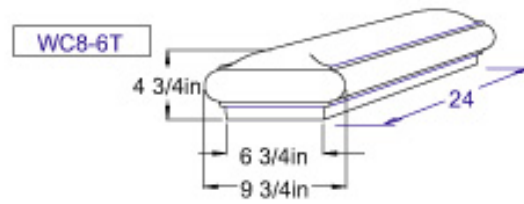
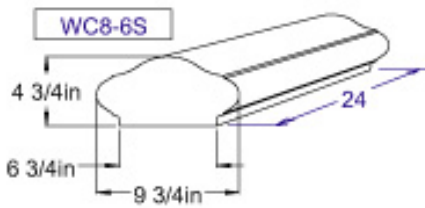

WALL CAP

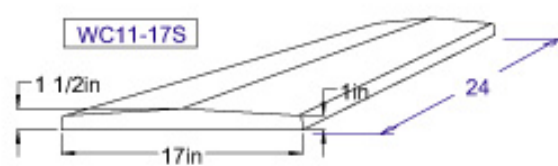
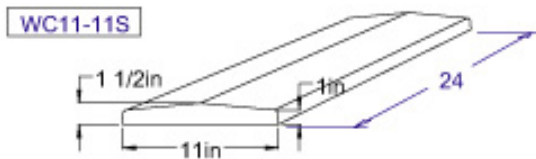
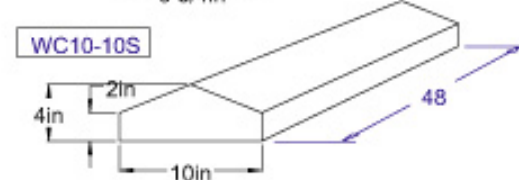
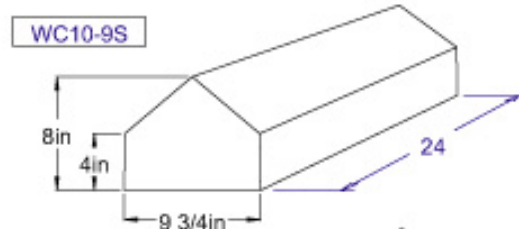
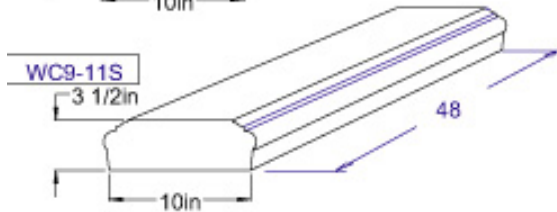
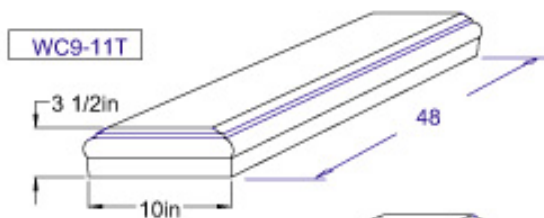
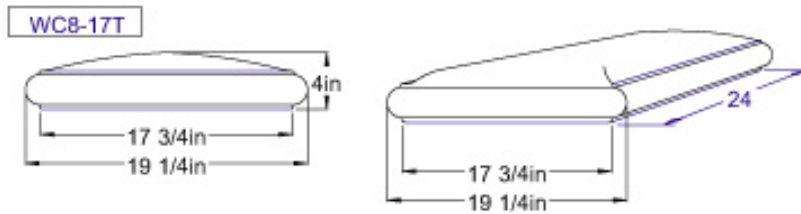
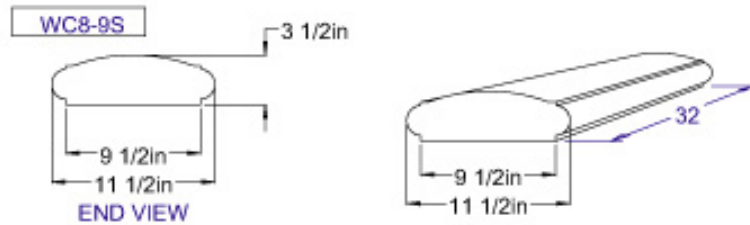

WALL CAP

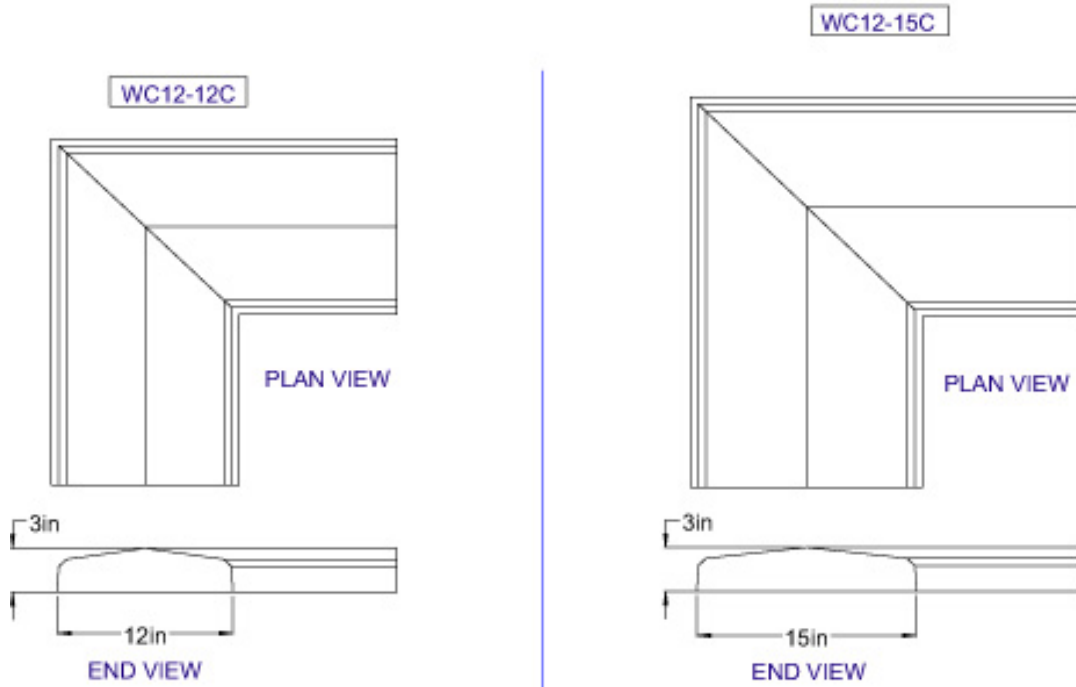
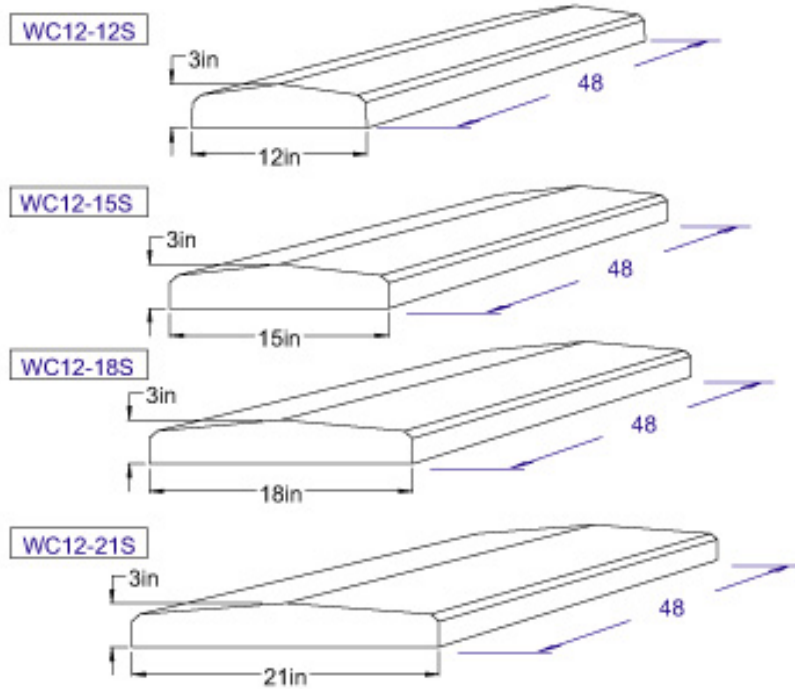

WALL CAP

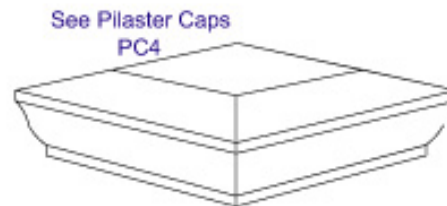
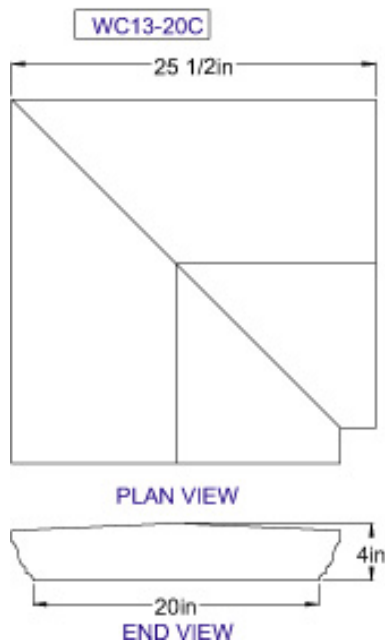
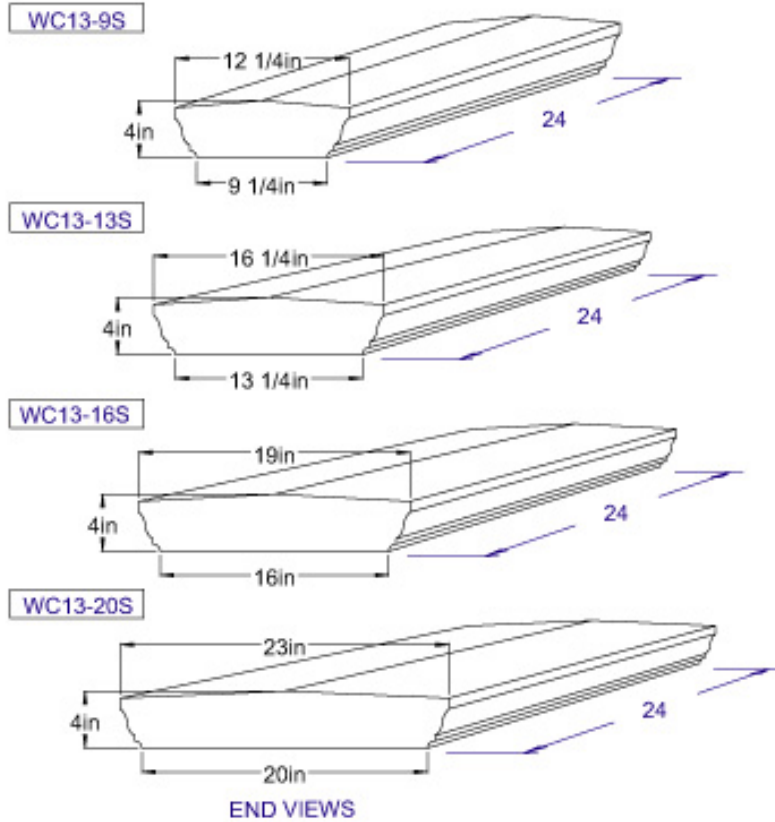

WALL CAP

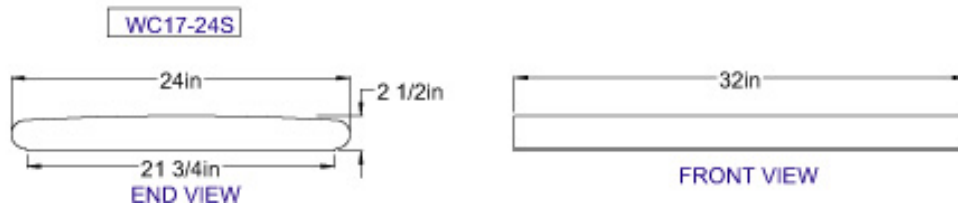
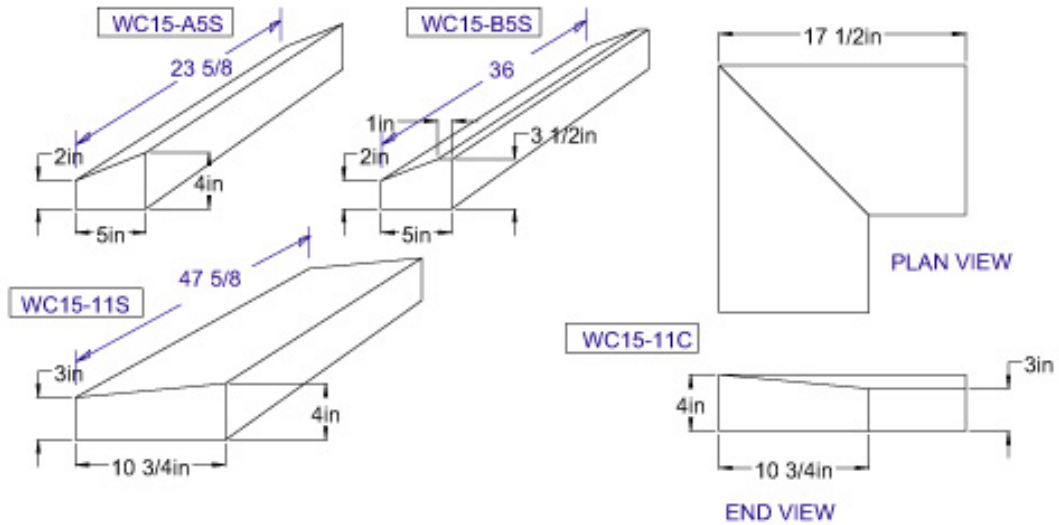
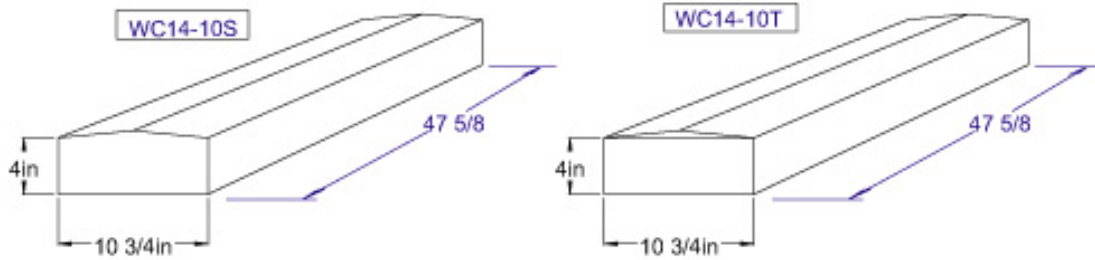

WALL CAP

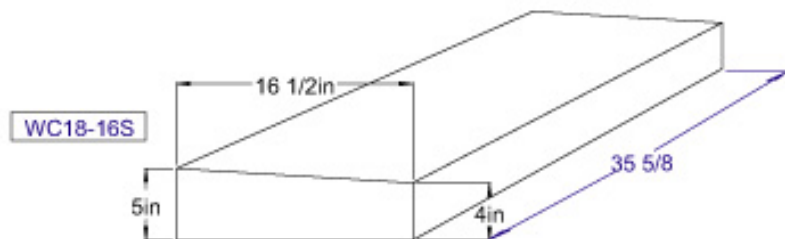
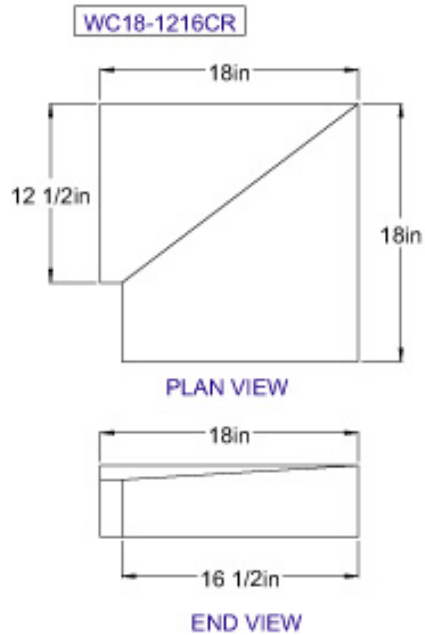
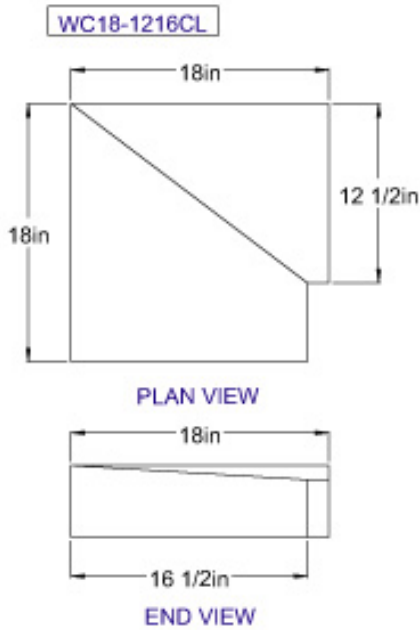
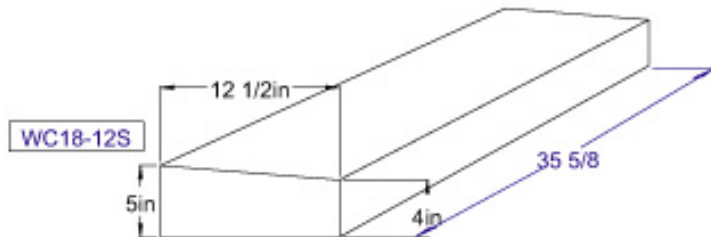

3 - 11

WALL CAP

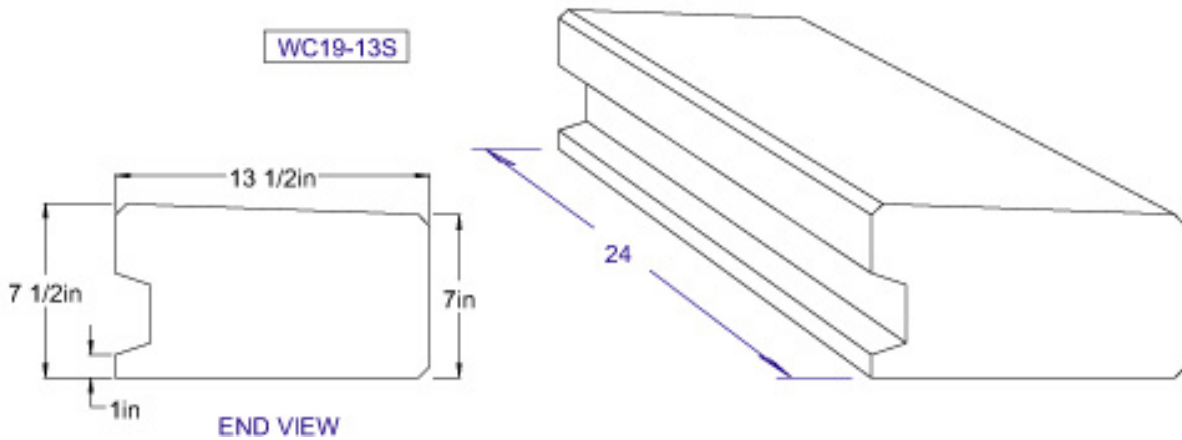
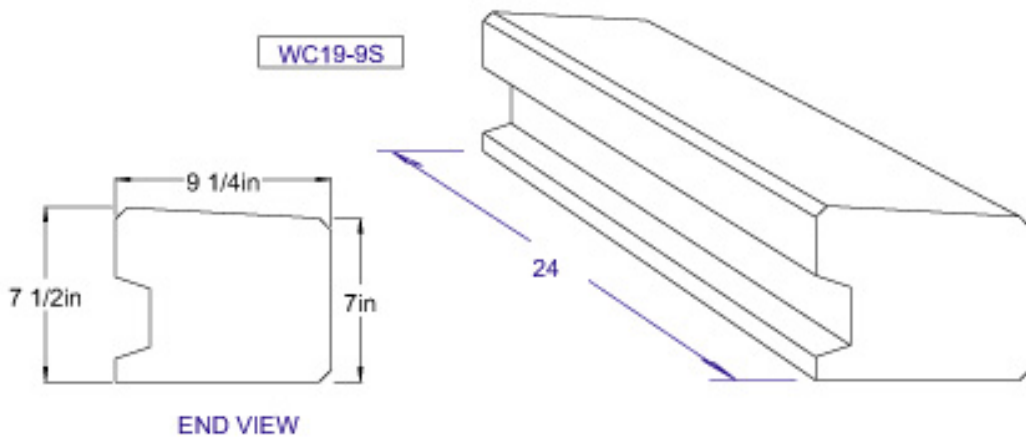

3 - 12

WALL CAP

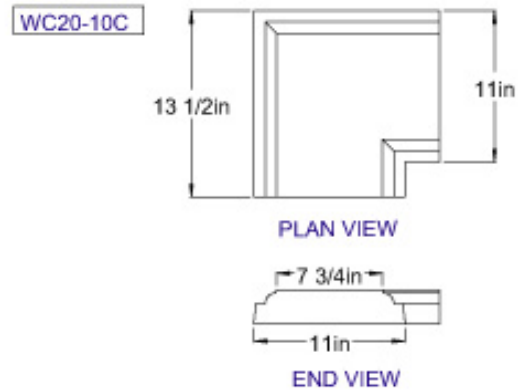
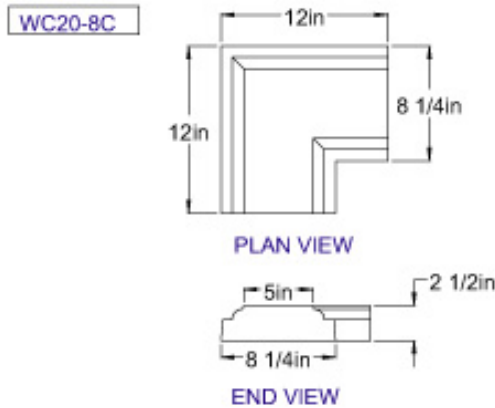
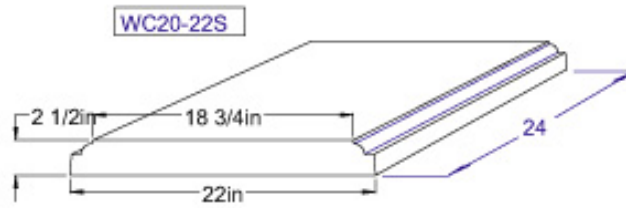
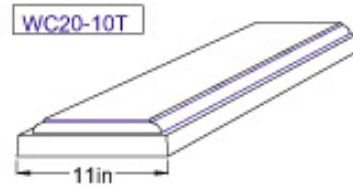
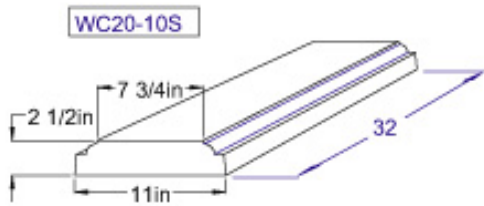
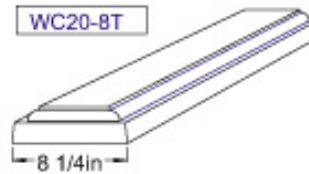
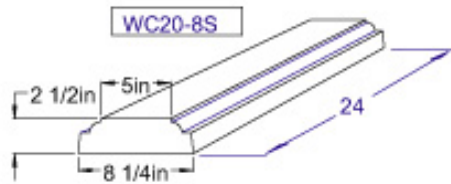

WALL CAP

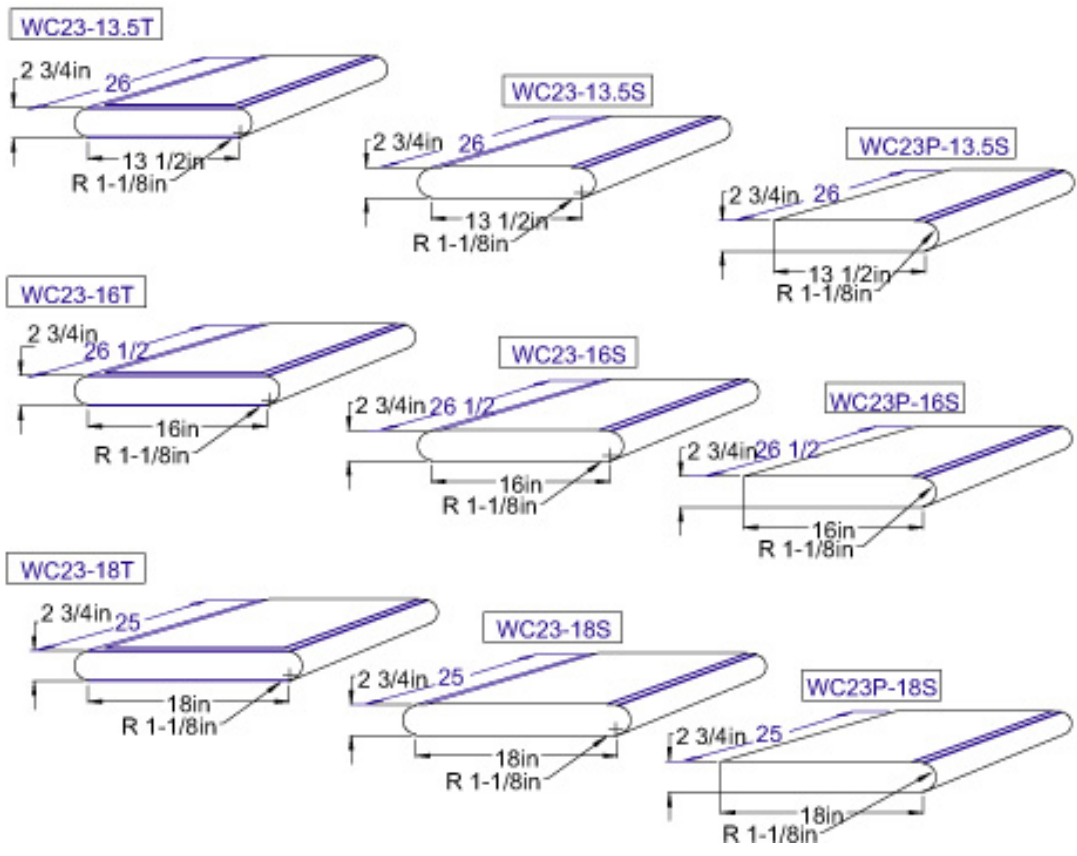
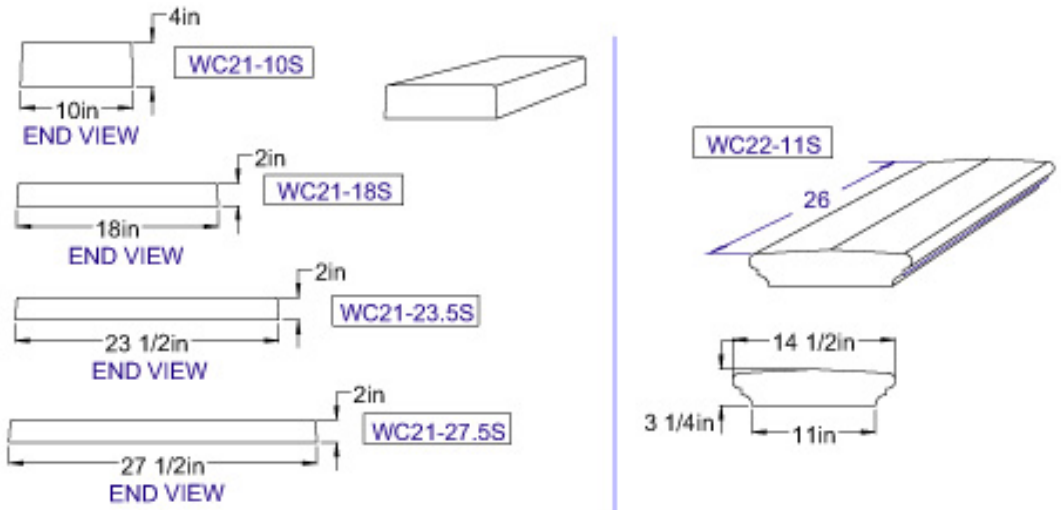

WALL CAP

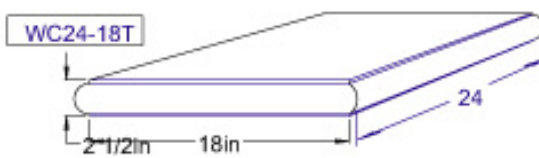
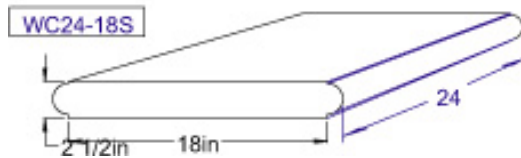
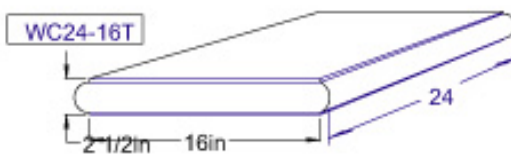
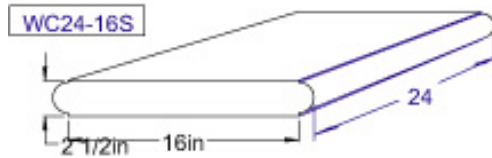
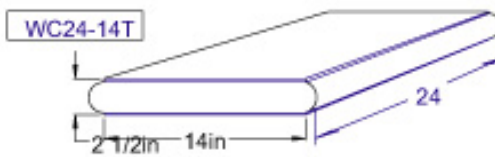
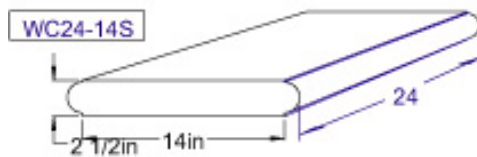
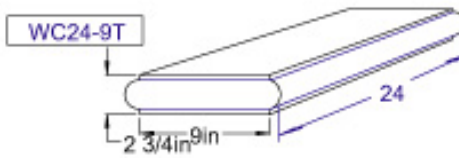
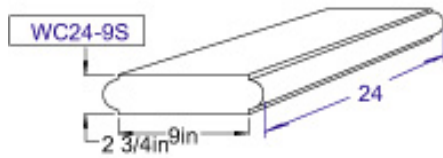
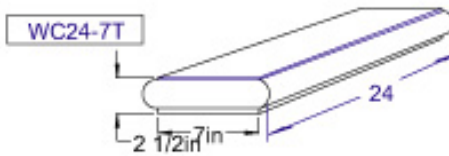
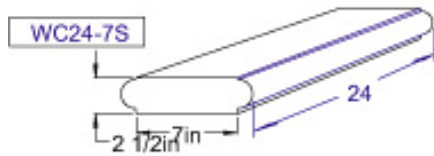
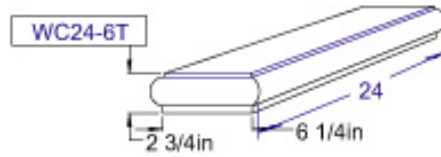
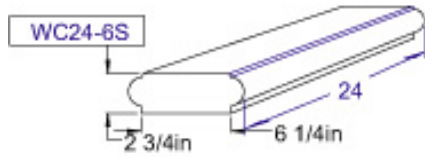

WALL CAP

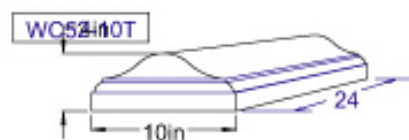
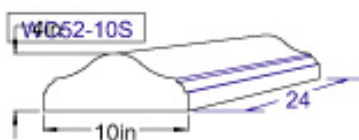
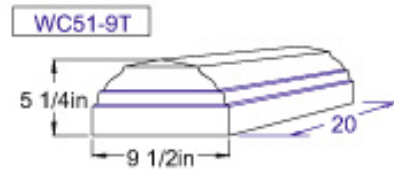
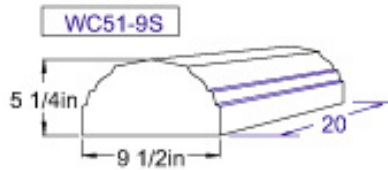
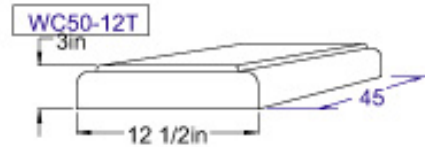
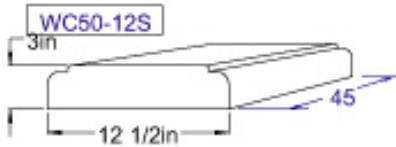
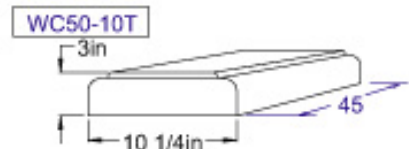
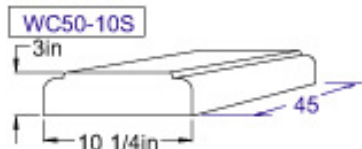
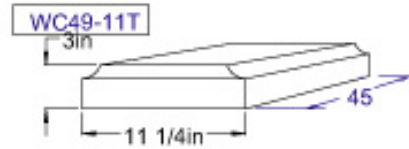
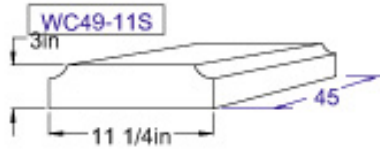
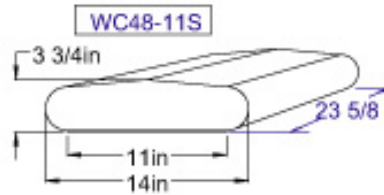

WALL CAP

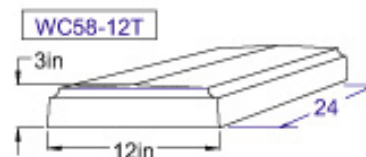
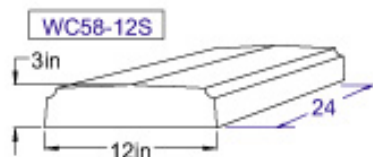
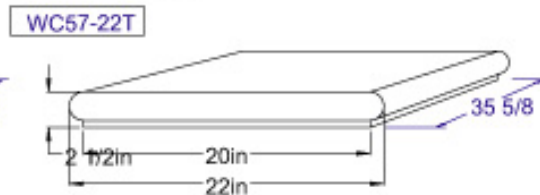
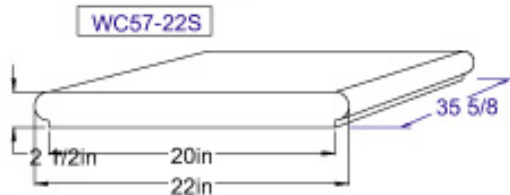
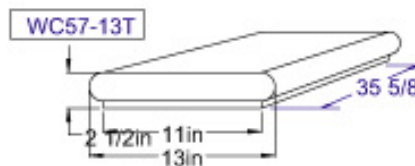
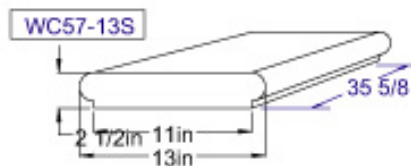
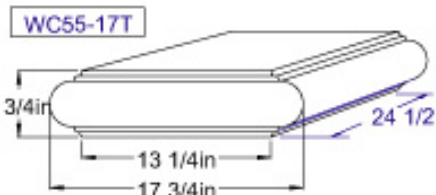
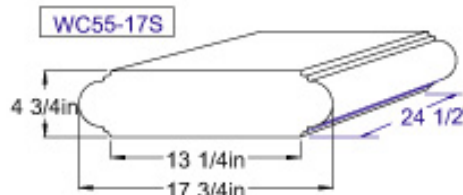
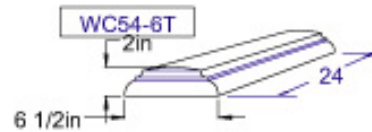
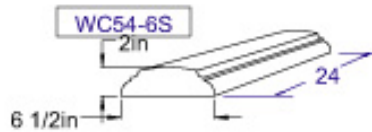
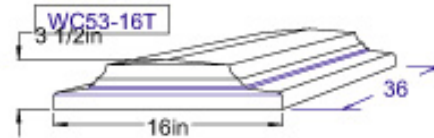
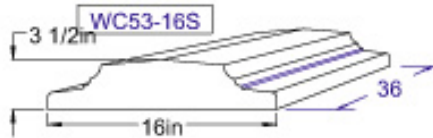
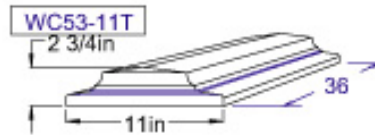
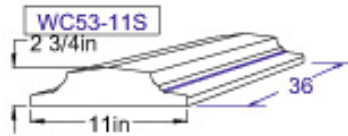

WALL CAP

WC60-19C

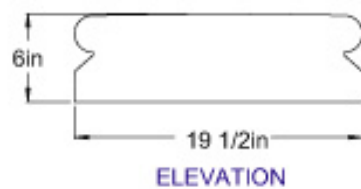
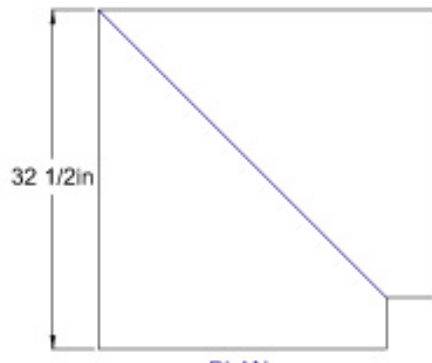

WC60-12R

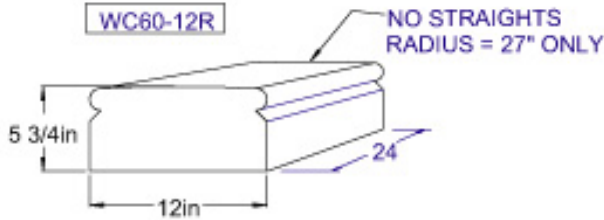

WC60-12T

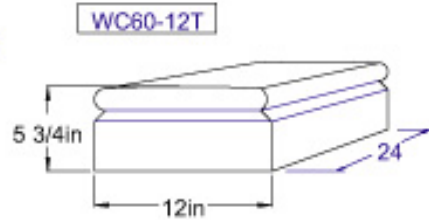

WC60-15S

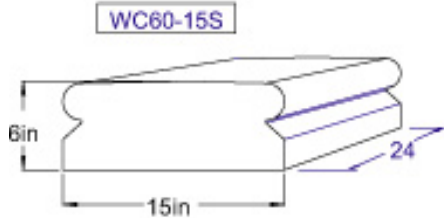

WC60-15T

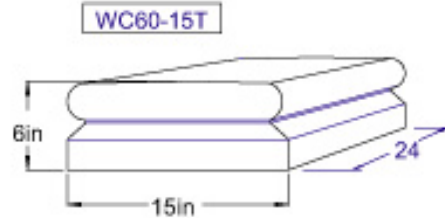

WC60-19S

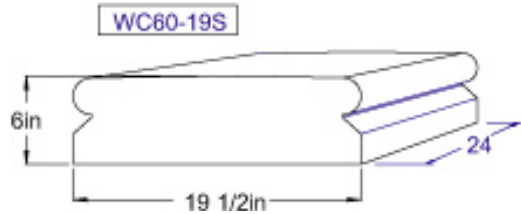

WC60-19T

